



Wheat and Rice Flour Moisture Tester PR-930
Operating Manual

Thank you for purchasing our Wheat and Rice Flour Moisture Tester, PR-930. This tester can measure the moisture of flour by simple operation, but proper operation is necessary for accurate moisture measurement.

Please read this operating manual carefully before use.

Table of contents

| | |
|------------------------------|----|
| Contents of Package..... | 3 |
| Part Names..... | 4 |
| Description of Display | 5 |
| How to Place Batteries..... | 7 |
| Before Measurement..... | 8 |
| Measurement..... | 9 |
| Average Value | 17 |
| Storage | 18 |
| Specifications..... | 19 |

Contents of Package

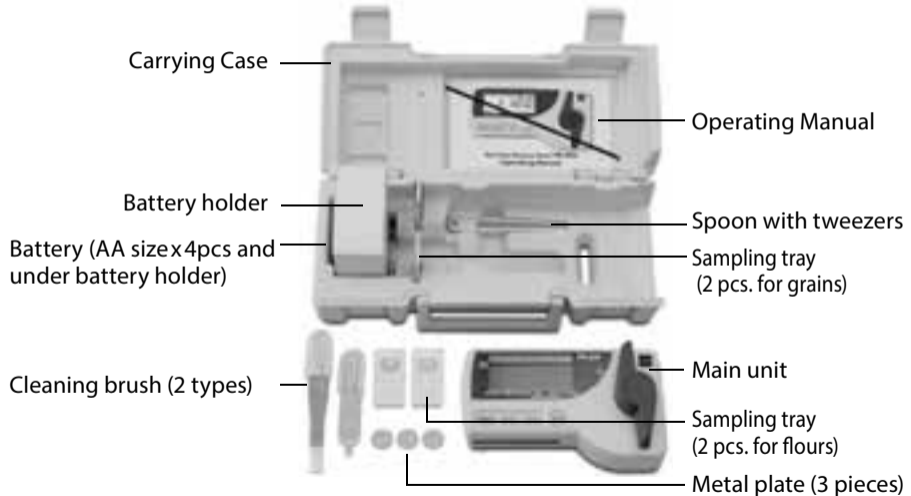

Part Names

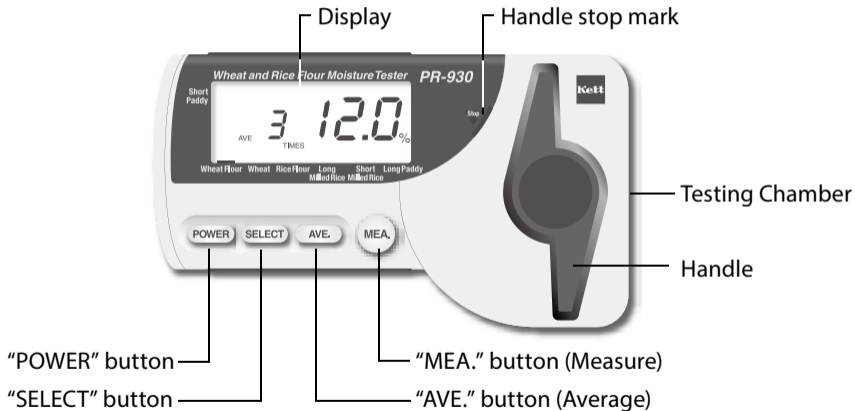

Description of display

This tester adopts the auto power off function. The power of the tester is automatically turned off in approx.

5 minutes after turning on the power if no operation is performed.



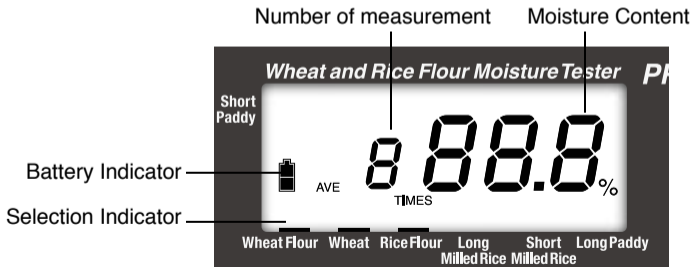

Use of backlight in the display section allows users to see the display clearly even in the dark.



Description of display

Meanings of special marks

The display may show marks as follows:

| | | |
|--------------|---|---|
| Battery mark |  Normal | Battery status is normal. (displayed immediately after pressing the power switch) |
| |  Caution | Battery is weak. (displayed immediately after pressing the power switch) |
| |  Caution | Battery is dead. Replace the batteries with new ones. (displayed immediately after pressing the power switch and while using) |
| Over mark |  Caution | Displayed when the measured result exceeded the upper limit of the measurement range |
| Under mark |  Caution | Displayed when the measured result fell below the lower limit of the measurement range, or the contact between the test sample tray and the measuring unit of the main body was poor. |

- When measurement is performed with the sampling tray empty or the measuring unit is poorly insulated due to condensation, high humidity, contamination, etc., the over mark, under mark, or other meaningless numbers may be displayed. In such a case, clean the measuring unit and dry it well in a natural way.***

How to Place Batteries

- 1** Take out the main unit from the carrying case.
- 2** Take out the batteries from under the battery holder.
- 3** Open the battery box on the back side of the main unit, and place 4 batteries appropriately.



Battery replacement

When the battery is running out, the battery mark lights up at the left side of the display. Replace all 4 batteries (AA) with new ones.

Those batteries are gradually discharging even when the tester is not used.

It is recommended to always use new batteries.

Place batteries in the correct polarity

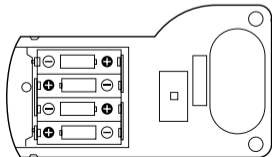

Let the tester temperature be the temperature of the test sample.

PR-930 is equipped with a temperature compensation circuit. However the test unit and samples are required to be thermally stabilized before measurement.

- 1 Press the "POWER" button. All of the backlight, all characters on the display section, and marks light up for 2 seconds.
The backlight goes out, and the tester becomes a standby state for measuring.



All display immediately after pressing the "POWER" button



"Wheat Flour" measuring state

Measurement

2 Scoop wheat flour with the spoon with tweezers and use the grip of the cleaning brush to level off the rice flour.



3 Put wheat flour on the sampling tray and shake the tray slightly to flatten the flour.



- 4** Put the metal plate on the wheat flour and press it gently with your finger. Perform measurement with the metal disc put on.



- 5** Press the "SELECT" button and repeat until the Selection Indicator and the abbreviation for name of the product you wish to test appears. The selected item is memorized even after turning off the power.

Measurement

- 6** When measurement is performed for whole wheat, long or short milled rice, or paddy use the spoon with tweezers to scoop the sample on sampling tray flatwise.



Evenly in one layer in the sampling



Insufficient



Evenly Placed
in one layer



Too Many

- 7** Rotate the handle counterclockwise to let the sampling tray enter the testing chamber. Place the sample evenly in the sampling tray, and insert it into the testing chamber until the guide line is hid.

Note: Failure to observe this may cause the tip of the handle to damage the plastic portion of sampling tray. Be sure to fully insert the tray.

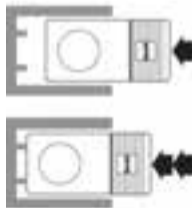
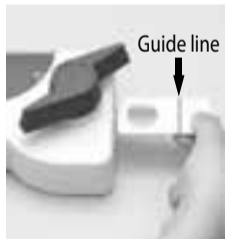

▲ Designated position

Proper placement



Incorrect placement

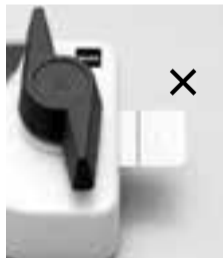

Measurement

- 8** Slowly rotate the handle clockwise. When the tip of the handle reaches the sample, fully rotate the handle to the "handle stop mark" holding the handle firmly.

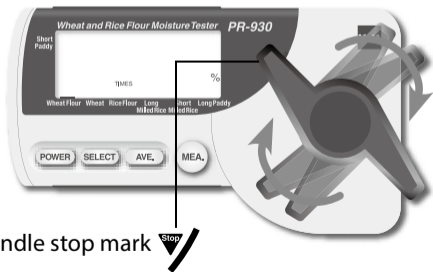

- 9** Press the "MEA." button, and the decimal point blinks, the backlight lights up, and the moisture content and measuring number are displayed thereafter.



The backlight goes out after 4 seconds, but the moisture content remains being displayed. After a lapse of 5 minutes, the power is automatically turns off and all the displayed items are cleared.

Pressing the "POWER" button while the display is in the on state allows users to turn off the power manually.

10 For continuous measurement, perform the next measurement while the last measured value is displayed.

Replace the test sample, fully rotate the handle, and press the "MEA." button.

The last measured value disappears and the new measured value is displayed. The measuring count also changes at the same time.

Measurement

11 Clean testing chamber inside, sampling tray, and metal plate after every measurement. (Pictures 1, 2, and 3) If the last test sample remains, proper measurement cannot be performed.

For continuous measurement, disconnect the handle and remove the attached sample and contamination from the tip of the handle and contact section sometimes. (Pictures 4 and 5)

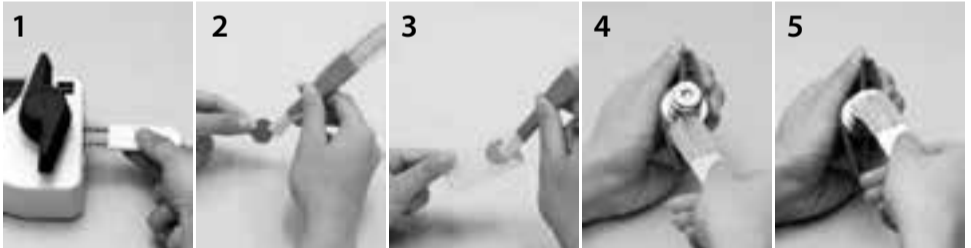

Pressing the "AVE." button after several measurements can obtain the average value of the measured moisture contents. The average value calculated from the measured values of the measuring count 2 to 9 is displayed with the average characters and number of measurement times.

Note1: *To obtain the average value of moisture contents, press the "AVE." button within 5 minutes after measurement. After the last measured value disappears, the average calculation function does not work. The initial state is restored in the following states:*

- *When the power is turned off*
- *When the "SELECT" button is pressed*
- *When the "AVE." button is pressed*
- *When the continuous measurement count exceeds 9*

Note 2: *AVE characters are displayed while an average value is displayed.*

Storage

Observe the following instructions to keep moisture tester for a long period of time:

- *Be sure to remove the batteries.*
- *Clean every portion of the main body in a careful manner. Especially for the measuring unit, disconnect the handle and clean the inner contact section sufficiently.*
- *Be sure to put the tester together with accessories in the carrying case and keep them in a cool place avoiding direct sunlight.*



Specifications

| | | | |
|----------------------------------|--|--|--|
| Applications / Measurement range | Wheat flour 11-18% Wheat 9-30% Rice flour 8-18% | Long milled rice 10-20% Short milled rice..... 10-20% | Long paddy 10-35% Short paddy..... 10-30% |
| Measurement precision | Flours : standard error of 0.25%(1 σ) at 130C 5g 2hrs method (Entire range) Grains: standard error of 0.5%(1 σ) at 130C 5g crushed 2hrs method (Under 20% range) * If the measurement is made at a different temperature than 20C, measurement precision may be larger than stated. | | |
| Display format | Digital (LCD, minimum display digit 0.1%, backlight equipped) | | |
| Operating temperature range | 5 – 40 °C | | |
| Temperature compensation | Automatic temperature correction using thermistor | | |
| Power supply | 1.5 V (AA battery) x 4 pieces (auto power off function after 5 minutes) Power consumption : Max. 0.3 W | | |
| Dimensions and weight | 164 (W) x 94 (D) x 64.5 (H) mm, Approx. 0.44 kg | | |
| Accessories | Sampling tray 4 pieces (2pcs per each of rice flour and milled rice), Metal Plate (3 pcs), Cleaning brush (2types), Spoon with tweezers, Battery (AA size x4pcs), Battery holder, Carrying case, Operating Manual | | |

Notes

Copying all of the contents of this user manual without prior written consent is strictly prohibited.

The contents of this user manual may be changed at any time in the future without any prior notice.

The appearance and/or representations of the products and parts depicted in this user manual may not appear exactly as their actual counterparts, but this does not affect their operation or functionality.

This manual was intended to be written as clearly and accurately as possible. However, if you are unclear about anything in this user manual or notice any missing information, please contact us directly.

We cannot be held responsible for any actions or effects resulting from the execution of any operations outlined in this user manual.



KETT ELECTRIC LABORATORY